

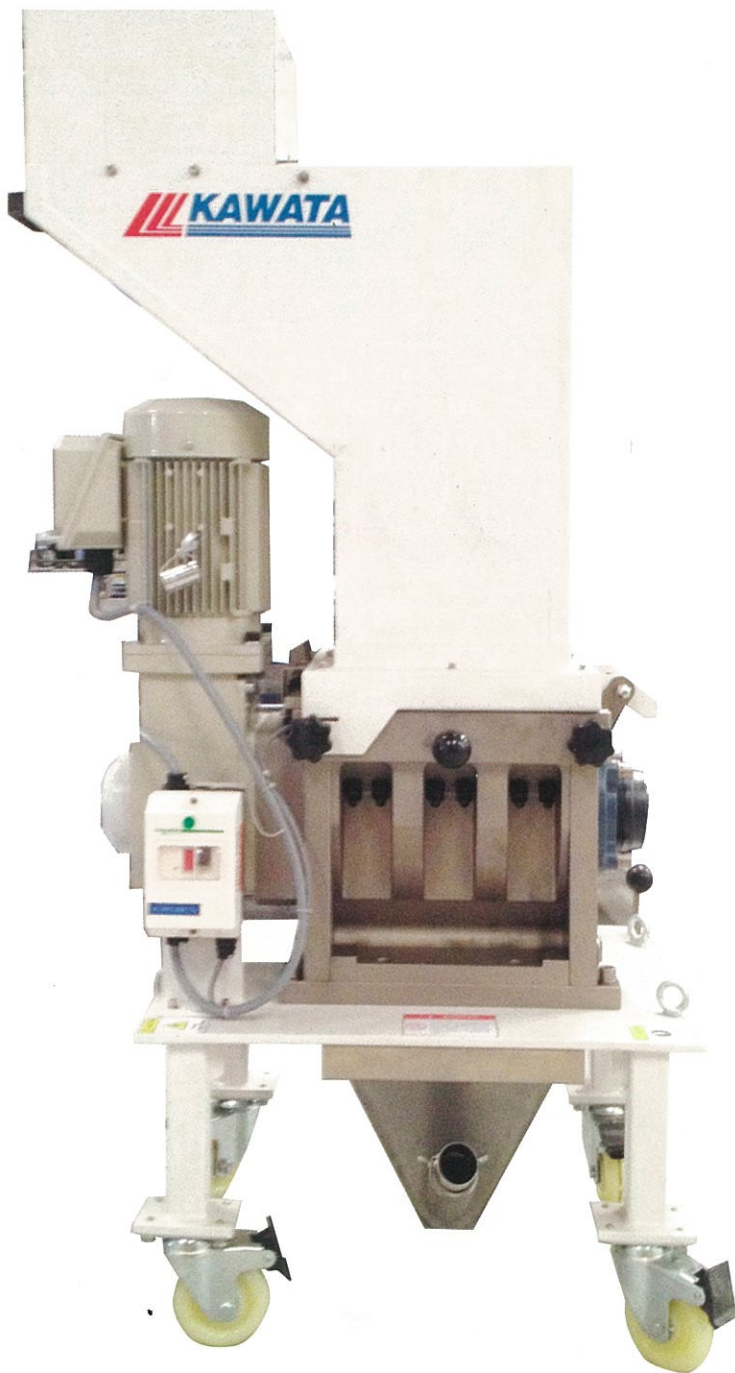

# ***G MASTER***

LOW SPEED GRANULATOR



**KGS series**

**G  
M  
A  
S  
T  
E  
R**

# KGS series

The most suitable (low speed) granulator for in-line recycling of engineering plastic runners. Only KAWATA as top maker of the plastic recycling equipment offers high reliability and easier cleaning of the machine.

Opening  
157.5°  
(KGS-250)

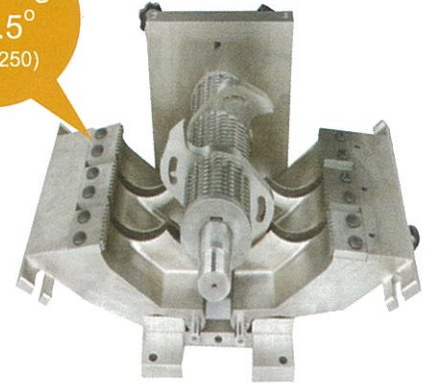

Easiest  
Cleaning

When you open the double door housing, which has high rigidity, as the original structure, you cannot find any useless frame upward for cleaning

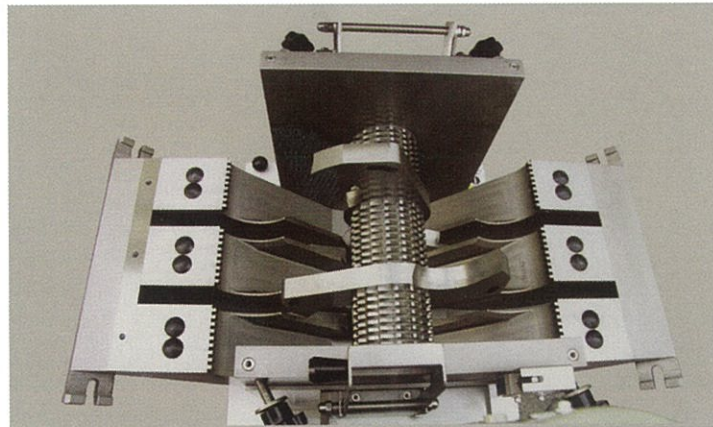

Grinding  
performance

Scissors cutting action of crushing blades improves grinding efficiency and generation of powder

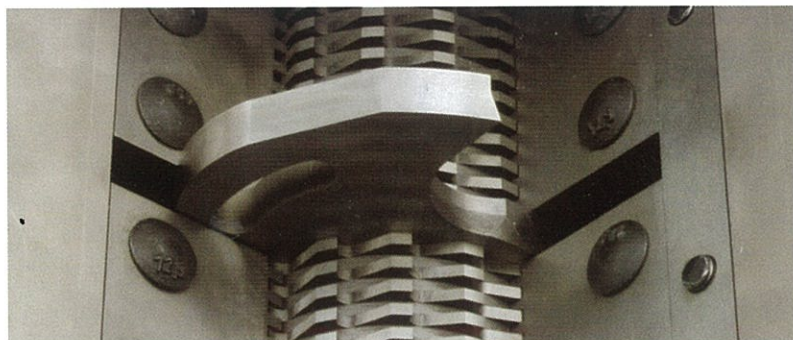



# KGS series

## Other Standards

- The housing is finished by electroless nickel plating after original surface treating.
- The driving motor installed upturned, protecting the motor damage from the grease dropping into the reduction gear.
- The dump chute is made of anti-vibration steel plate.
- Oilless bearings are used for opening the housing.
- The rotary discharge of the ends of the main axis can prevent power from entering the axis,
- You can put the pump chute in four positions every 90 degrees.
- The fine-scissors of the granulator adopts a shape design so that scissors teeth are uneasy to crack.

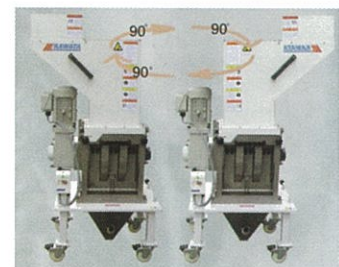
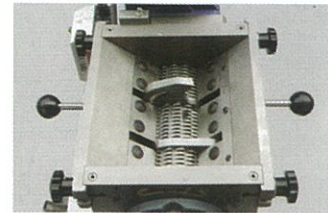

## Recycling

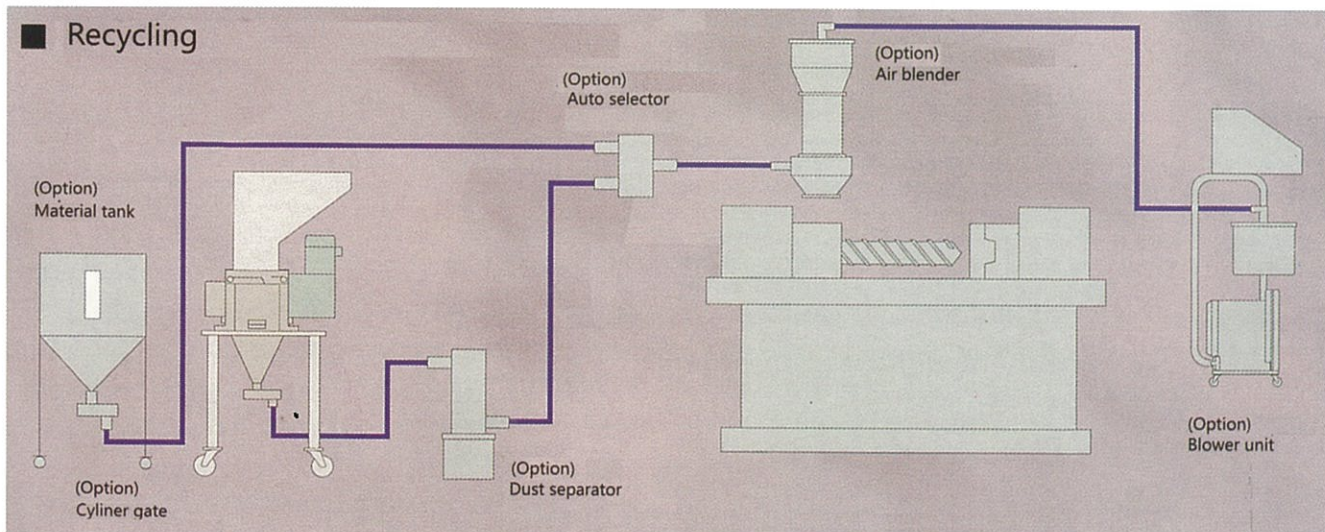



# KGS series

## Specifications

Option:



Magnet filter

Items	Model	KGS-250-KS	KGS-350-KS	KGS-450-KS
Inlet size	(mm)	238 x 257	315 x 318	411 x 410
Opening size of grinding (cutting) blades	(mm)	250 x 252	335 x 335	432 x 432
Speed of revolution	(rpm) (50/60Hz)	24.2/29.2	24.2/29.2	18.1/21.9
Grinding blades	(pcs)	3	3	3
Cutter size	(WxD) (mm)	4 x 5	5 x 6	6 x 7
Crushing blades	(pcs)	2	2	2
Fixed blade	(pcs)	6	6	6
Motor capacity	(kW)	1.1	1.5	2.2
Power capacity		AC 220/380/415V 50 Hz 3W+E		
Weight	(kg)	200	350	700
Painting color		Y15-85A JPMA Y15-85a, semigloss		
Accessories		Conveying hose/Power cable/5m		

## Outline dimension

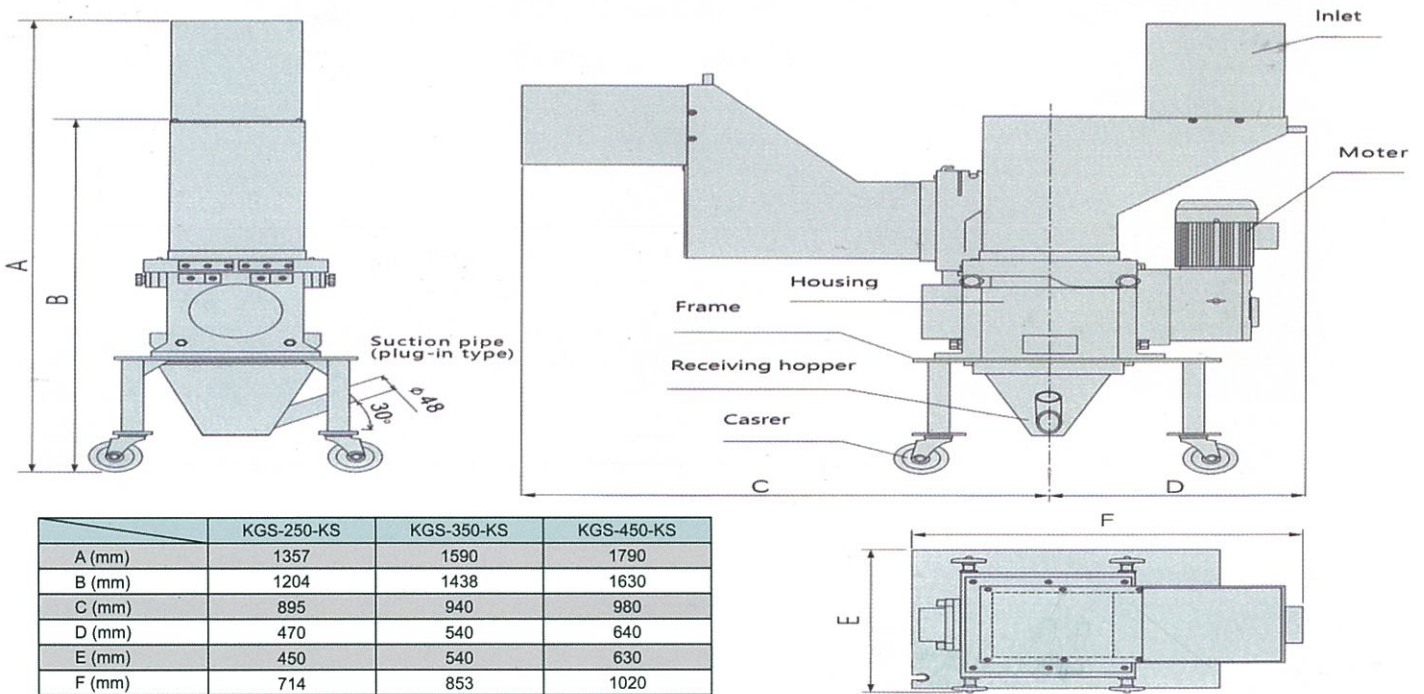

### PT. KAWATA MARKETING INDONESIA

Grand Slipi Tower, 8 floor unit M  
 Jl, Let. Jehd. S Parman Kav 22 ~ 24  
 Slipi, Jakarta Barat 11480

Tlp : (62-21) 290 21992  
 Fax : (62-21) 290 21993  
 Email : adm\_sales@kawata-mi.co.id

### PT. KAWATA INDONESIA

Jababeka Techno Park KIJ III E2C  
 Pasir Gombong, Cikarang Utara,  
 Bekasi, Jawa Barat

Tlp : (62-21) 8984 4560  
 Fax : (62-21) 8984 4559  
 Email : sales@kawata.co.id